

TOWER LIGHT TOPPER



Tower Light Topper

Part Number: 104-08000

Warning: In case of removal of the diffuser bezel do not look straight into the LED's since this may cause serious eyes injuries!

TOWER LIGHT TOPPER

Features

- Designed to be mounted on top of any standard classic tower light with the included special top mounting bracket
- Great for advertising special machine features such as Multi-Denomination, Ticket-In Ticket-Out, Hot New Game, Server Based Gaming, etc.
- Translucent bezel with 20 ultra bright Nichia multi-color RGB LED's provide light output for a elegant multi-colored lightshow
- Pre-Programmed with 8 unique flashing patterns and 7 different color combinations
- Backlit by 9 white high power Nichia LED's
- Operates on 12vdc power
- Artwork panel and tower light are not included
- Small in size: 7.64" W x 6.83" H x 2.34" D

Overall Size and Connection

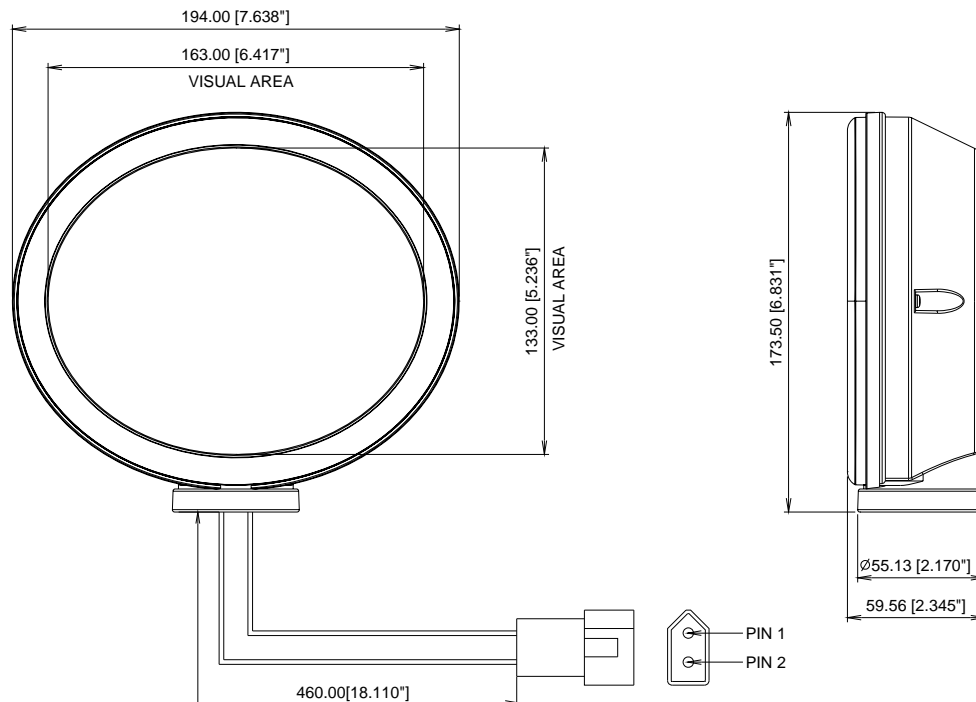

Wire Connection (Power in)

NO	WIRE COLOR	DESCRIPTION	PIN	TOPPER CONNECTOR TYPE	MACHINE CONNECTOR TYPE
J1	ORANGE	POWER 12VDC	1	MOLEX MALE 03-09-2022	MOLEX FEMALE 03-09-1022 / 02-09-1118 (SOCKET)
	BLACK	POWER GROUND	2		

Important:

1. Shut-off the power from the host machine until installation work is completed.
2. Power supply: 12VDC 3A

TOWER LIGHT TOPPER

Dimension of Artwork Plate (3.0mm Thick)

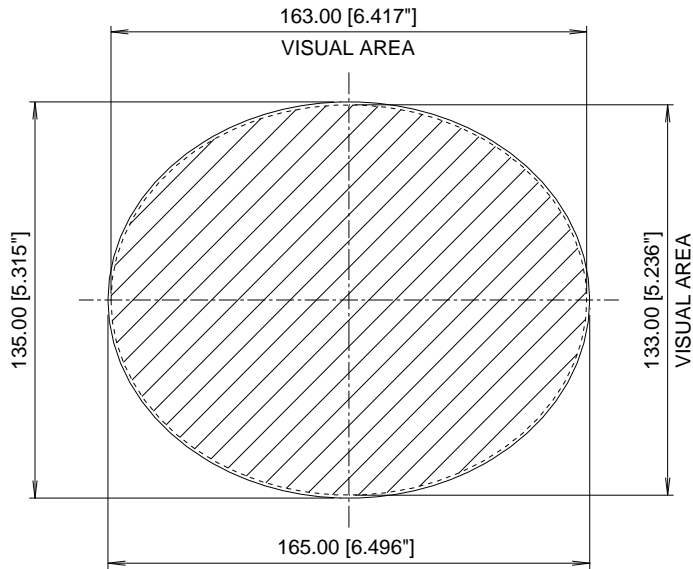

Exploded Drawing:

ITEM	P/N	DESCRIPTION	MATERIAL	QTY
1	RP020-670-01	HOUSING	ABS 94V-0	1
2	RP010-670-01	BEZEL	PC 94V-2	1
3	RP070-670-01	LENS CAP	PC 94V-0	1
4	RP020-670-02S	BASE WITH NUT (CHROME)	ABS 94-HB	1
-	RP020-670-02B	BASE WITH NUT (BK. CHROME)	ABS 94-HB	OPTIONAL
-	RP020-670-02Y	BASE WITH NUT (GOLDEN)	ABS 94-HB	OPTIONAL
5	RS670-E01-01	MAIN PCB ASSY	FR-4 94V-0	1
6	RS670-E02-01	PCB-LED ASSY	FR-4 94V-0	2
7	RM301-026-06	SCREW 2.6X6 BA		6
8	RM311-030-10	SCREW M3X10PA (NI)		2
9	RM411-030-10	SCREW M3X10MSP		1
10	RM601-670-01	NUT M4 X20		1

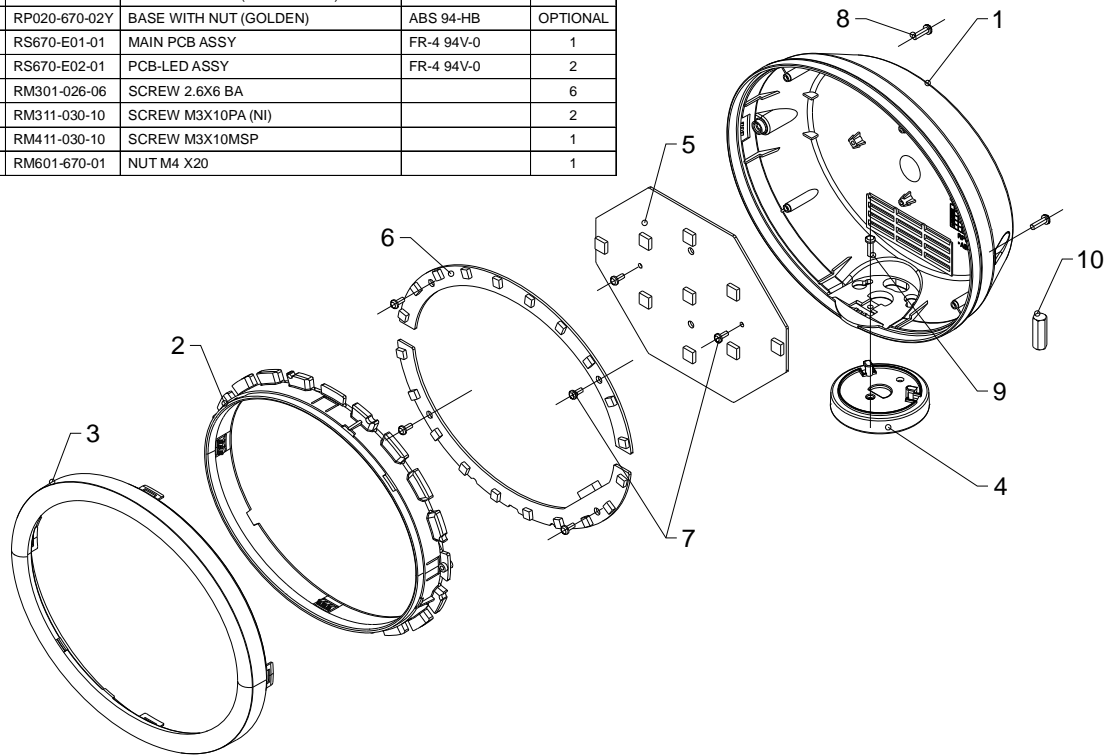

- ◆ Tower Light and Artwork plate not included
- ◆ Cable not shown in the drawing

TOWER LIGHT TOPPER

Setting Flashing Pattern Mode for Topper:

You may select flashing patterns as below:

1. Cycling through 8 pre-programmed flashing patterns (Default setting)
2. Press MODE button once - Topper will switch to next flashing pattern and stay on this pattern until MODE button is activated again.
3. Press and hold MODE button for 3 seconds - Topper will resume to default setting and cycle through the pre-programmed patterns.
4. Last flashing mode will be stored to memory when power off.

Setting Color for Topper:

You may select flashing color set out of seven pre-defined combinations:

1. Switch to the flashing pattern mode you want to change the colors.
2. Press COLOR button on the main control board once - Topper will switch to next color set for this flashing pattern until COLOR button is activated again.
3. Last color setting will be stored to memory when power off.
4. The color sets are defined as follow:

Color Flashing Patterns	
1	Red - Blue - White (Default)
2	Red - White - Green
3	Red - Yellow - White
4	Blue - White - Yellow
5	Blue - Purple - White
6	Green - Blue - Yellow
7	Blue - Red - Green

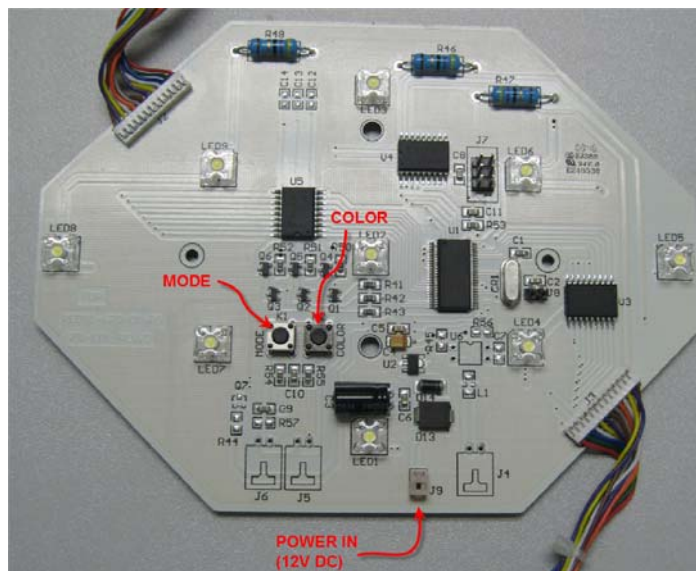

TOWER LIGHT TOPPER

Installation:



1. Remove existing Tower Light from host machine.
2. Unlock cap nut and remove top cover.
3. Disconnect cable with 2 pins connector from Tower Light Topper PCB at Location J9.
4. Arrange the cable through the Tower Light from the bottom to the top with 2-pin connector facing up.
5. Assemble Topper to Tower Light and secure the hexagon post (10).
6. Reconnect the 2 pin connector to PCB at Location J9.
7. The Tower Light Topper is now ready to install back on the host machine.
8. Connect 12Vdc 3A to the 2 pins Molex plug.



RoHS Compliance:

To our best knowledge, our products are in compliance with European Union Directive 2002/95/EC on the restriction of use of certain hazardous substances (“**RoHS Directives**”).

FCC Compliance:

The Tower Light Topper had been tested and complied with the requirements of Federal Communication Commission [FCC] Rules and Regulations Part 15.

TOWER LIGHT TOPPER

CE Compliance:

The Tower Light Topper had been tested and complied with the EMC requirements per CE standards.

		
THE HONG KONG STANDARDS AND TESTING CENTRE LTD. EC DECLARATION OF CONFORMITY		
Reference Number:	EMC0905165DOC	
Dynamics Chinotec Industries (HK) Ltd. 809-810 Block A, Hoi Luen Ind. Ctr. 55 Hoi Yuen Road, Kwun Tong Kowloon, Hong Kong		
declare the product		
Description:	Tower Light Topper	
Brand Name:	N/A	
Model:	104-08000	
complies with the requirements of the EC Council Directive on electromagnetic compatibility 2004/108/EC		
Applicable Standard(s) with amendments: EN55015: 2006 +A1: 2007 EN61547: 1995 +A1: 2000		
General Remarks: This declaration is only valid when used in conjunction with the technical file(s) refers to HM162988. This declaration applies specifically to the sample(s) investigated in the technical report mentioned above and not to the bulk. The CE markings as shown below can be affixed on the product after preparation of necessary conformity documentation, as stipulated in Articles of the Council Directive 2004/108/EC.		
Manufacturer/Importer	CE	Test Laboratory
 Signature		
		For  Dr. LEE Kam Chuen ElectroMagnetic Compatibility Department For and on behalf of The Hong Kong Standards and Testing Centre Ltd.
	www.hkstc.org	Date of Issue: 2009-01-20

Note: The specifications and information contained here are for quick reference only and are subjected to change without notice.

For more info: www.suzohapp.com